

Patterns

NRHA



National Reining Horse Association

3021 West Reno Ave • Oklahoma City, OK 73107

(405) 946-7400

SLIDING INTO THE
NEXT
50
YEARS
— OF —
NRHA



NRHA ™

The Slide of your Life



Entry Level Reining

- ★ *Compete with riders at your level from different backgrounds*
- ★ *All you need is an Associate Membership*
- ★ *Win Green Reiner Rewards including belt buckles from Montana Silversmiths*



NRHA 

#SLIDEOFYOURLIFE • (405) 946-7400 • NRHA.COM

Find Shows, NRHA Affiliates
and NRHA Professionals in
your area at NRHA.com

REINING

“To rein a horse is not only to guide him, but also to control his every movement. The best reined horse should be willingly guided or controlled with little or no apparent resistance and dictated to completely. Any movement on his own must be considered a lack of control. All deviations from the exact written pattern must be considered a lack of or temporary loss of control; and therefore, a fault that must be marked down according to severity of deviation. After deducting all faults set here within, against execution of the pattern and the horse’s overall performance, credit should be given for smoothness, finesse, attitude, quickness and authority of performing various maneuvers, while using controlled speed which raises the difficulty level and makes him more exciting and pleasing to watch to an audience.”

To be certain you have the most up-to-date patterns, visit nrha.com for the most current official version of the *NRHA Handbook and Pattern Book*.

NRHA



#SLIDEOFYOURLIFE • (405) 946-7400 • NRHA.COM

NOW IT'S EASY TO FIND A PRO!

NRHA.COM/FINDAPRO

- Learn more about a Professional's business and training standards!

- Search by types of training and lesson types!

- A trusted resource that includes industry credentials and more!

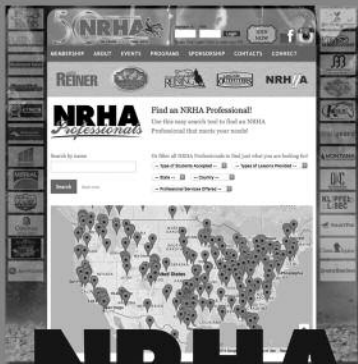

NRHA

Professionals



SCORING

The scoring of reining horses is on a positive numeric scale with 70 denoting a correct performance. NRHA patterns are comprised of several distinct maneuver groups, which judges are asked to evaluate on an individual basis depending on execution as dictated by the pattern description and the rules for judging. The individual maneuvers are scored in $\frac{1}{2}$ point increments from a low of $-1\frac{1}{2}$ (extremely poor quality) to a high of $+1\frac{1}{2}$ (excellent quality) with a score of 0 denoting a maneuver that is correct with no degree of difficulty. The total of the scores applied to the maneuver groups is combined with the starting score of 70 and from this gross maneuver score, any penalties are deducted to calculate the horse's final score, which is announced after each horse works.

PATTERN

1. The following patterns are to be worked as stated, not as drawn. The drawn pattern is just to give the general idea of what the pattern will look like in the arena.
2. Markers will be placed on the wall or fence of the arena as follows:
 - (I) at the center of the arena
 - (II) at least 50' (15 meters) from each end wall.
3. Where designated in the pattern for stops to be beyond a marker, the horse should begin his stop after he passes the specified marker.
4. Each pattern is drawn so that the bottom of the page represents the end of the arena entered by contestants and must be run as such. In the event that an arena has only one gate and it be in the exact middle of the side, that side shall represent the right side of the page the pattern is drawn on.
5. All horses will be judged immediately upon entering the arena and judging will cease after the last maneuver. Any fault incurred prior to the commencement of a pattern will be scored according to the Rules of Judging.
6. All judges' decisions are final.
7. With the exception of Entry Level Ride & Slide Level 1 classes, the following patterns are the only patterns to be used at NRHA events. NRHA Green classes should use NRHA patterns but simple lead changes are allowed.

PATTERN

1

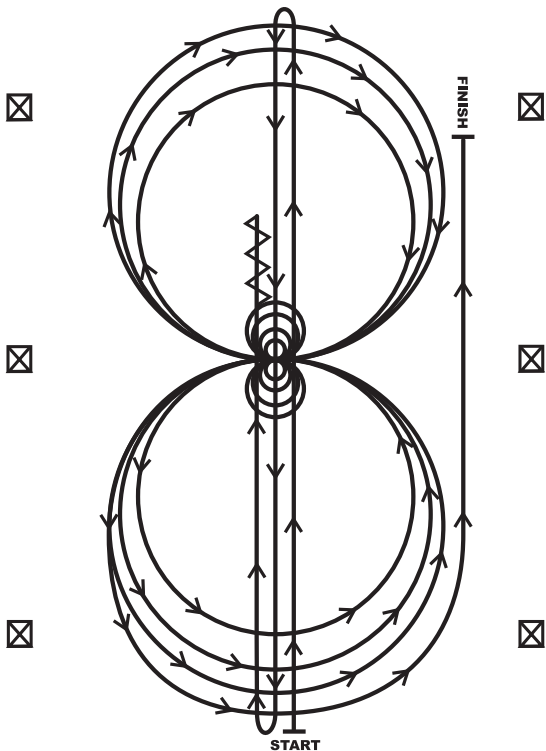

PATTERN

1

1. Run at speed to the far end of the arena past the end marker and do a left rollback—no hesitation.
2. Run to the opposite end of the arena past the end marker and do a right rollback—no hesitation.
3. Run past the center marker and do a sliding stop. Back up to center of the arena or at least ten feet (three meters). Hesitate.
4. Complete four spins to the right. Hesitate.
5. Complete four and one-quarter spins to the left so that horse is facing left wall or fence. Hesitate.
6. Beginning on the left lead, complete three circles to the left: the first circle large and fast; the second circle small and slow; the third circle large and fast. Change leads at the center of the arena.
7. Complete three circles to the right: the first circle large and fast; the second circle small and slow; the third circle large and fast. Change leads at the center of the arena.
8. Begin a large circle to the left but do not close this circle. Run straight up the right side of the arena past the center marker and do a sliding stop at least twenty feet (six meters) from wall or fence. Hesitate to demonstrate the completion of the pattern.

PATTERN

2

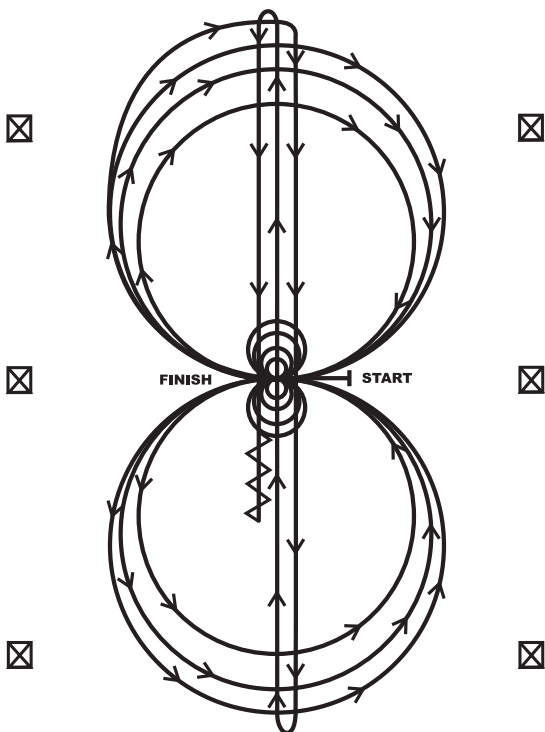

PATTERN

2

Horses may walk or jog to the center of arena. Horses must walk or stop prior to starting pattern. Beginning at the center of the arena facing the left wall or fence.

1. Beginning on the right lead, complete three circles to the right: the first circle small and slow; the next two circles large and fast. Change leads at the center of the arena.

2. Complete three circles to the left: the first circle small and slow; the next two circles large and fast. Change leads at the center of the arena.

3. Continue around previous circle to the right. At the top of the circle, run down the middle to the far end of the arena past the end marker and do a right rollback—no hesitation.

4. Run up the middle to the opposite end of the arena past the end marker and do a left rollback—no hesitation.

5. Run past the center marker and do a sliding stop. Back up to the center of the arena or at least ten feet (three meters). Hesitate.

6. Complete four spins to the right. Hesitate.

7. Complete four spins to the left. Hesitate to demonstrate the completion of the pattern.

PATTERN

3

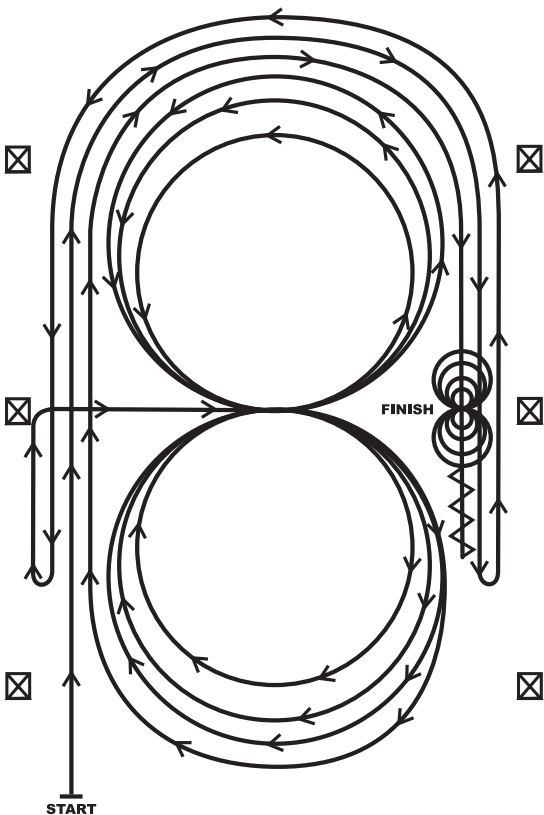

PATTERN

3

1. Beginning, lope straight up the left side of the arena, circle the top end of the arena, and staying at least twenty feet (six meters) from the walls or fence, run straight down the opposite or right side of the arena past the center marker and do a left rollback—no hesitation.
2. Continue straight up the right side of the arena circle back around the top of the arena, and staying at least twenty feet (six meters) from the walls or fence, run straight down the left side of the arena past the center marker and do a right rollback—no hesitation.
3. Continue up the left side of the arena to the center marker. At the center marker, the horse should be on the right lead. Guide the horse to the center of the arena on the right lead and complete three circles to the right: the first two circles large and fast; the third circle small and slow. Change leads at the center of the arena.
4. Complete three circles to the left: the first two circles large and fast; the third circle small and slow. Change leads in the center of the arena.
5. Begin a large circle to the right but do not close this circle. Continue up the left side of the arena, circle the top of the arena, and staying at least twenty feet (six meters) from the walls or fence, run straight down the opposite or right side of the arena past the center marker and do a sliding stop. Back up at least ten feet (three meters). Hesitate.
6. Complete four spins to the right. Hesitate.
7. Complete four spins to the left. Hesitate to demonstrate completion of the pattern.

PATTERN

4

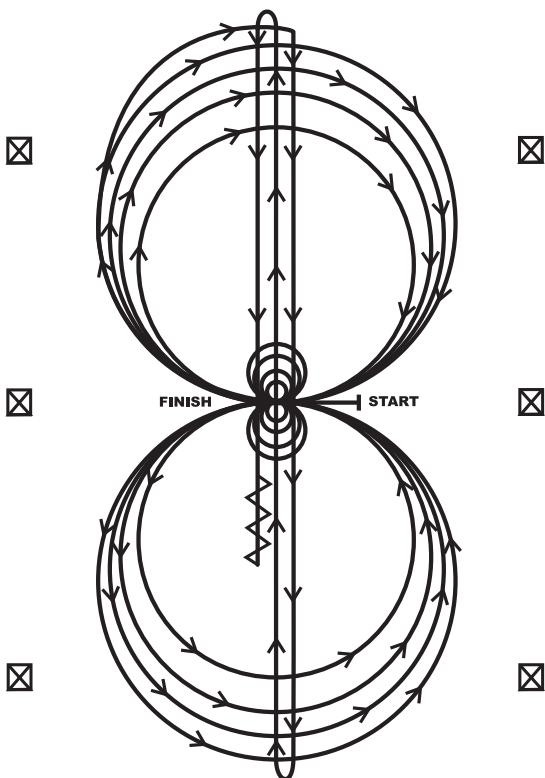

PATTERN

4

Horses may walk or jog to the center of the arena. Horses must walk or stop prior to starting pattern. Beginning at the center of the arena facing the left wall or fence.

1. Beginning on the right lead, complete three circles to the right: the first two large and fast; the third circle small and slow. Stop at the center of the arena. Hesitate.
2. Complete four spins to the right. Hesitate.
3. Beginning on the left lead, complete three circles to the left: the first two circles large and fast; the third circle small and slow. Stop at the center of the arena. Hesitate.
4. Complete four spins to the left. Hesitate.
5. Beginning on the right lead, run a large fast circle to the right, change leads at the center of the arena, run a large fast circle to the left, and change leads at the center of the arena. (Figure 8)
6. Continue around previous circle to the right. At the top of the circle, run down the middle to the far end of the arena past the end marker and do a right rollback—no hesitation.
7. Run up the middle to the opposite end of the arena past the end marker and do a left rollback—no hesitation.
8. Run past the center marker and do a sliding stop. Back up to the center of the arena or at least ten feet (three meters). Hesitate to demonstrate completion of the pattern.

PATTERN

5

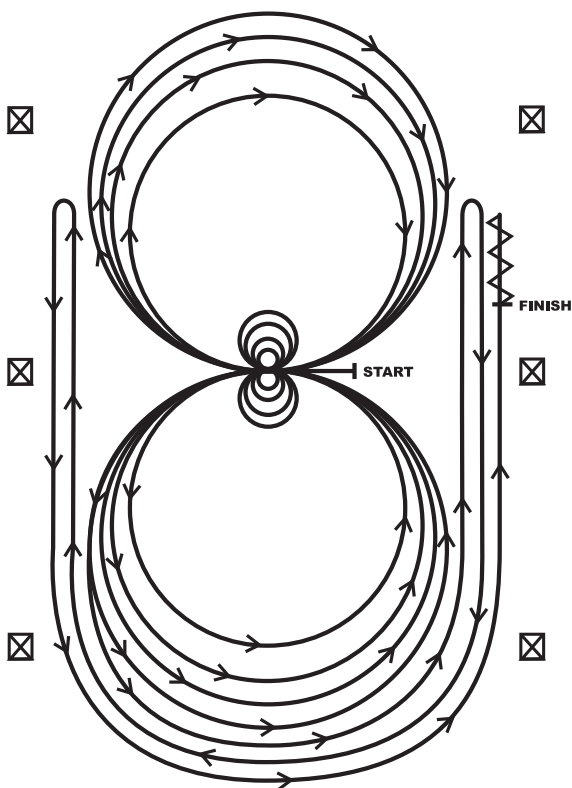

PATTERN

5

Horses may walk or jog to the center of arena. Horses must walk or stop prior to starting pattern. Beginning at the center of the arena facing the left wall or fence.

1. Beginning on the left lead, complete three circles to the left: the first two circles large and fast; the third circle small and slow. Stop at the center of the arena. Hesitate.
2. Complete four spins to the left. Hesitate.
3. Beginning on the right lead, complete three circles to the right: the first two circles large and fast; the third circle small and slow. Stop at the center of the arena. Hesitate.
4. Complete four spins to the right. Hesitate.
5. Beginning on the left lead, run a large fast circle to the left, change leads at the center of the arena, run a large fast circle to the right, and change leads at the center of the arena. (Figure 8)
6. Continue around previous circle to the left but do not close this circle. Run up the right side of the arena past the center marker and do a right rollback at least twenty feet (six meters) from the wall or fence—no hesitation.
7. Continue around previous circle but do not close this circle. Run up the left side of the arena past the center marker and do a left rollback at least twenty feet (six meters) from the wall or fence—no hesitation.
8. Continue back around previous circle but do not close this circle. Run up the right side of the arena past the center marker and do a sliding stop at least twenty feet (six meters) from the wall or fence. Back up at least ten feet (three meters). Hesitate to demonstrate completion of the pattern.

PATTERN

6

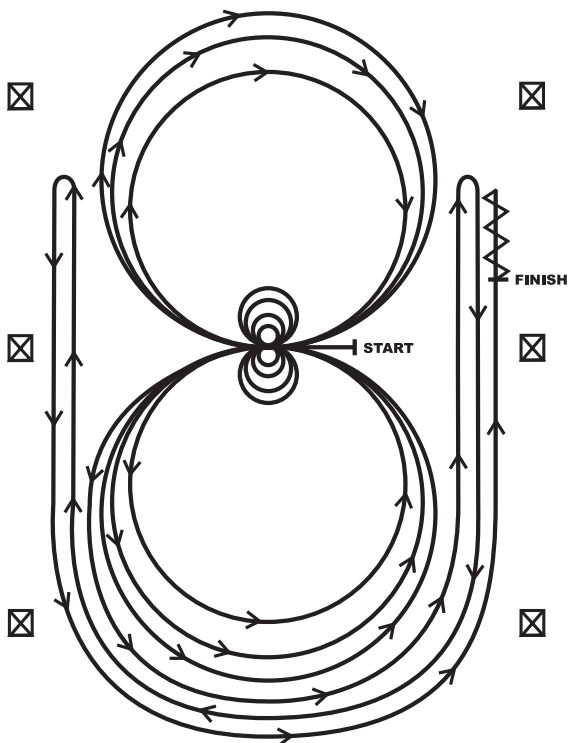

PATTERN

6

Horses may walk or jog to the center of arena. Horses must walk or stop prior to starting pattern. Beginning at the center of the arena facing the left wall or fence.

1. Complete four spins to the right. Hesitate.
2. Complete four spins to the left. Hesitate.
3. Beginning on the left lead, complete three circles to the left: the first two circles large and fast; the third circle small and slow. Change leads at the center of the arena.
4. Complete three circles to the right: the first two circles large and fast; the third circle small and slow. Change leads at the center of the arena.
5. Begin a large circle to the left but do not close this circle. Run up the right side of the arena past the center marker and do a right rollback at least twenty feet (six meters) from the wall or fence—no hesitation.
6. Continue back around previous circle but do not close this circle. Run up the left side of the arena past the center marker and do a left rollback at least twenty feet (six meters) from the wall or fence—no hesitation.
7. Continue back around previous circle but do not close this circle. Run up the right side of the arena past the center marker and do a sliding stop at least twenty feet (six meters) from the wall or fence. Back up at least ten feet (three meters). Hesitate to demonstrate the completion of the pattern.

PATTERN

7

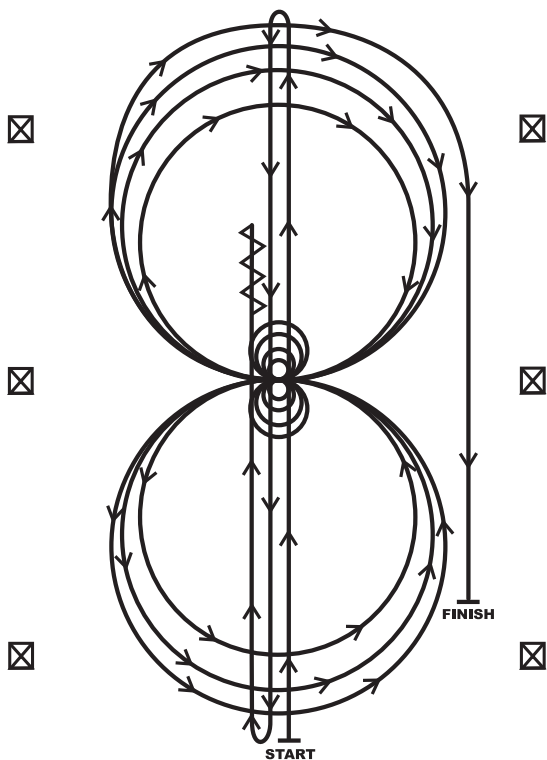

PATTERN

7

1. Run at speed to the far end of the arena past the end marker and do a left rollback—no hesitation.
2. Run to the opposite end of the arena past the end marker and do a right rollback—no hesitation.
3. Run past the center marker and do a sliding stop. Back up to the center of the arena or at least ten feet (three meters). Hesitate.
4. Complete four spins to the right. Hesitate.
5. Complete four and one-quarter spins to the left so that horse is facing left wall or fence. Hesitate.
6. Beginning on the right lead, complete three circles to the right: the first two circles large fast; the third circle small and slow. Change leads at the center of the arena.
7. Complete three circles to the left: the first two circles large fast; the third circle small and slow. Change leads at the center of the arena.
8. Begin a large circle to the right but do not close this circle. Run straight down the right side of the arena past the center marker and do a sliding stop at least twenty feet (six meters) from the wall or fence. Hesitate to demonstrate completion of the pattern.

PATTERN

8

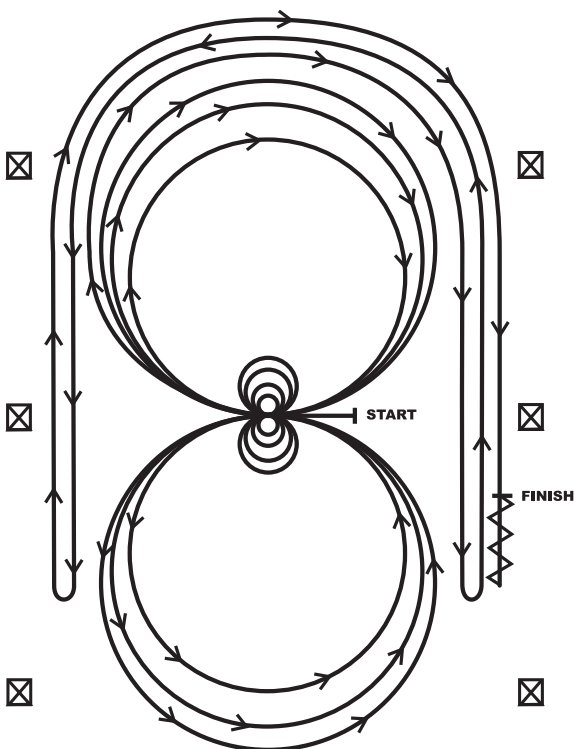

PATTERN

8

Horses may walk or jog to the center of arena. Horses must walk or stop prior to starting pattern. Beginning at the center of arena facing the left wall or fence.

1. Complete four spins to the left. Hesitate.
2. Complete four spins to the right. Hesitate.
3. Beginning on the right lead, complete three circles to the right: the first circle large and fast; the second circle small and slow; the third circle large and fast. Change leads at the center of the arena.
4. Complete three circles to the left: the first circle large and fast; the second circle small and slow; the third circle large and fast. Change leads at the center of the arena.
5. Begin a large circle to the right but do not close this circle. Run straight down the right side of the arena past the center marker and do a left rollback at least twenty feet (six meters) from the wall or fence—no hesitation.
6. Continue back around the previous circle but do not close this circle. Run down the left side of the arena past the center maker and do a right rollback at least twenty feet (six meters) from the wall or fence—no hesitation.
7. Continue back around the previous circle but do not close this circle. Run down the right side of the arena past the center marker and do a sliding stop at least twenty feet (six meters) from the wall or fence. Back up at least ten feet (three meters). Hesitate to demonstrate completion of the pattern.

PATTERN

9

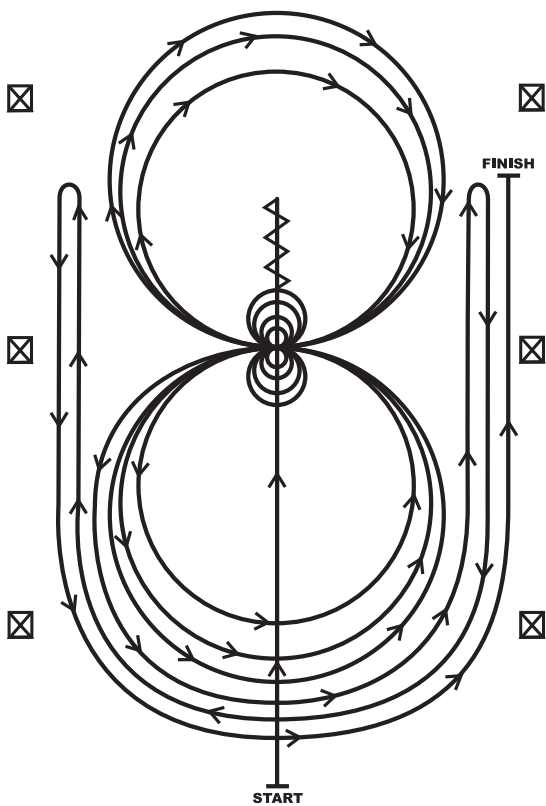

PATTERN

9

- 1.** Run past the center marker and do a sliding stop. Back up to the center of the arena or at least ten feet (three meters). Hesitate.
- 2.** Complete four spins to the right. Hesitate.
- 3.** Complete four and one-quarter spins to the left so that horse is facing the left wall or fence. Hesitate.
- 4.** Beginning on the left lead, complete three circles to the left: the first circle small and slow; the next two circles large and fast. Change leads at the center of the arena.
- 5.** Complete three circles to the right: the first circle small and slow; the next two circles large and fast. Change leads at the center of the arena.
- 6.** Begin a large circle to the left but do not close this circle. Run up the right side of the arena past the center marker and do a right rollback at least twenty feet (six meters) from the wall or fence—no hesitation.
- 7.** Continue back around the previous circle but do not close this circle. Run up the left side of the arena past the center marker and do a left rollback at least twenty feet (six meters) from the wall or fence—no hesitation.
- 8.** Continue back around previous circle but do not close this circle. Run up right side of the arena past the center marker and do a sliding stop at least twenty feet (six meters) from the wall or fence. Hesitate to demonstrate completion of the pattern.

PATTERN

10

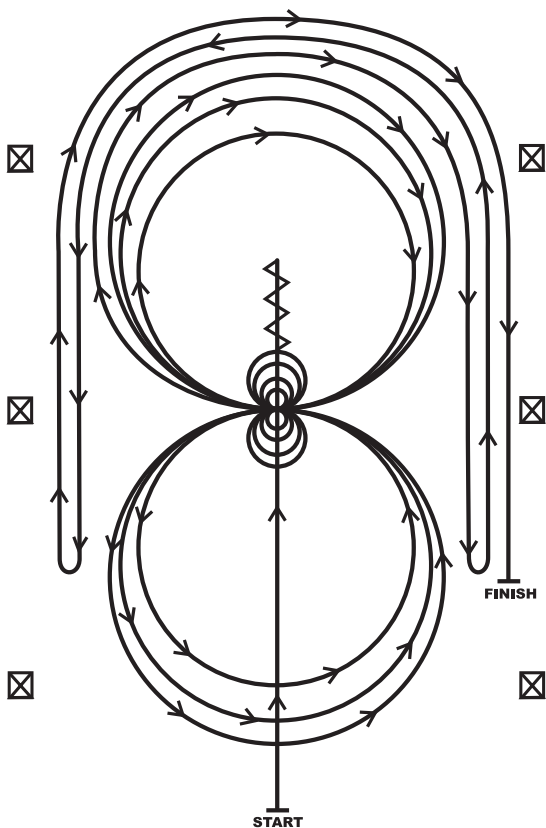

PATTERN

10

- 1.** Run past the center marker and do a sliding stop. Back up to the center of the arena or at least ten feet (three meters). Hesitate.
- 2.** Complete four spins to the right. Hesitate.
- 3.** Complete four and one-quarter spins to the left so that the horse is facing the left wall or fence. Hesitate.
- 4.** Beginning on the right lead, complete three circles to the right: the first two circles large and fast, the third circle small and slow. Change leads at the center of the arena.
- 5.** Complete three circles to the left: the first circle small and slow, the next two circles large and fast. Change leads at the center of the arena.
- 6.** Begin a large circle to the right but do not close this circle. Run down the right side of the arena past the center marker and do a left rollback at least twenty feet (six meters) from the wall or fence—no hesitation.
- 7.** Continue back around the previous circle but do not close this circle. Run down the left side of the arena past the center and do a right rollback at least twenty feet (six meters) from the wall or fence—no hesitation.
- 8.** Continue back around previous circle but do not close this circle. Run down the right side of the arena past the center marker and do a sliding stop at least twenty feet (six meters) from the wall or fence. Hesitate to demonstrate completion of the pattern.

PATTERN

11

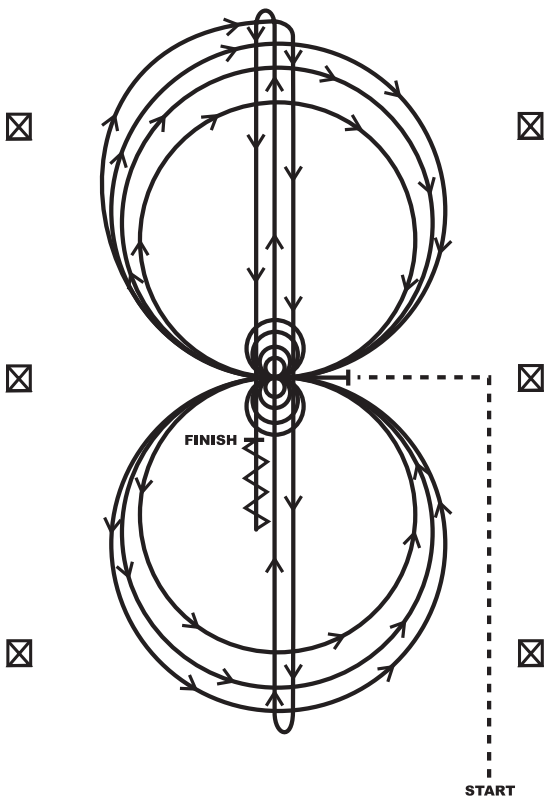

PATTERN

11

Horses must jog to the center of the arena (see Judges Guide for maneuver description). Horses must walk or stop prior to starting the pattern. Beginning at the center of the arena facing the left wall or fence.

1. Complete four spins to the left. Hesitate.
2. Complete four spins to the right. Hesitate.
3. Beginning on the right lead complete three circles to the right; the first circle small and slow; the next two circles large and fast. Change leads at the center of the arena.
4. Complete three circles to the left; the first circle small and slow; the next two circles large and fast. Change leads at the center of the arena.
5. Begin a large circle to the right, but do not close this circle. Run down the center of the arena past the end marker and do a right rollback—no hesitation.
6. Run up the middle to the opposite end of the arena past the end marker and do a left rollback—no hesitation.
7. Run past the center marker and do a sliding stop. Back up to the center of the arena or at least ten feet (three meters). Hesitate to demonstrate completion of the pattern.

PATTERN

12

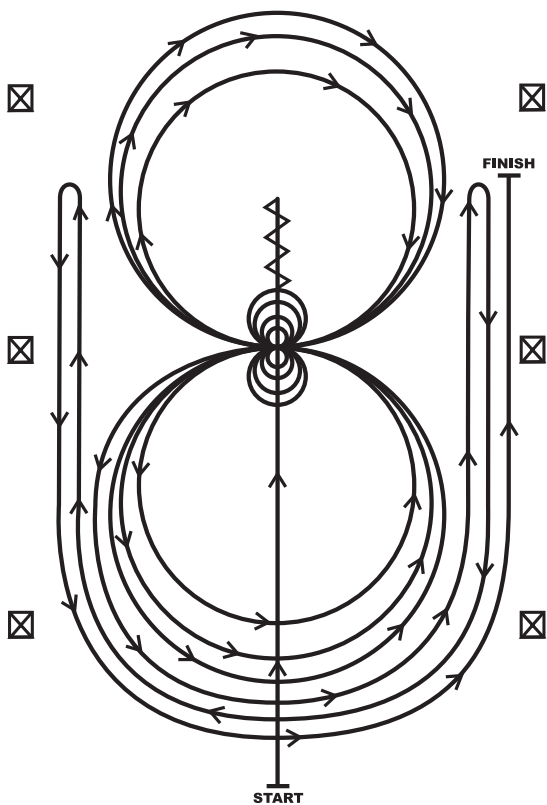

PATTERN

12

- 1.** Run past the center marker and do a sliding stop. Back up to the center of the arena or at least 10 feet (3 meters). Hesitate.
- 2.** Complete four spins to the right. Hesitate.
- 3.** Complete four and one-quarter spins to the left so that the horse is facing the left wall or fence. Hesitate.
- 4.** Beginning on the left lead, compete three circles to the left: the first two circles large and fast; the third circle small and slow. Change leads at the center of the arena.
- 5.** Complete three circles to the right: the first two circles large and fast; the third circle small and slow. Change leads at the center for the arena.
- 6.** Begin a large circle to the left but do not close this circle. Run up the right side of the arena past the center marker and do a right rollback at least 20 feet (6 meters) from the wall or fence-no hesitation.
- 7.** Continue back around previous circle but to not close this circle. Run up the left side of the arena and past the center marker and do a left rollback at least 20 feet (6 meters) from the wall or fence-no hesitation.
- 8.** Continue back around previous circle but do not close this circle. Run up the right side of the arena past the center marker and do a sliding stop at least 20 feet (6 meters) from the wall or fence. Hesitate to demonstrate completion of pattern.

PATTERN

13

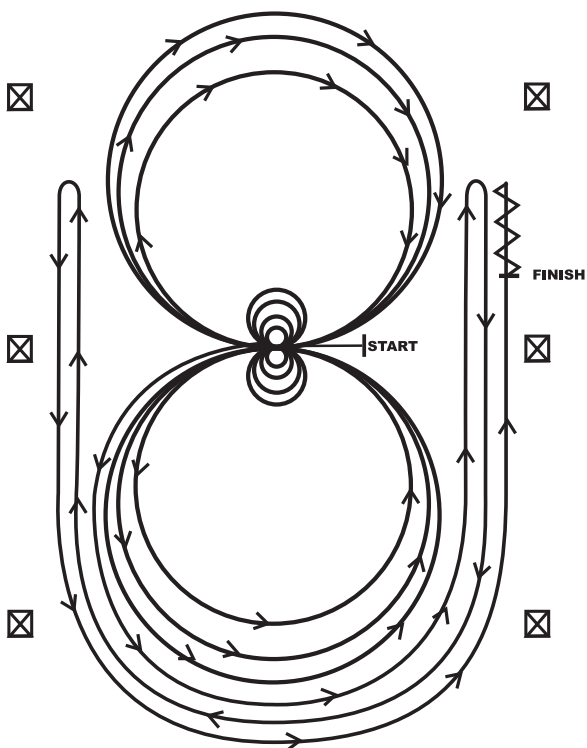

PATTERN

13

Horses must walk or stop prior to starting pattern. Beginning at the center of the arena facing the left wall or fence.

1. Beginning on the left lead, complete two circles to the left: the first circle large and fast; the second circle small and slow. Stop at the center of the arena
2. Complete four spins to the left. Hesitate.
3. Beginning on the right lead, complete two circles to the right: the first being large and fast; the second circle small and slow. Stop at the center of the arena.
4. Complete four spins to the right. Hesitate.
5. Beginning on the left lead, run a large fast circle to the left, change leads at the center of the arena, run a large fast circle to the right, and change leads at the center of the arena.
6. Continue around previous circle to the left but do not close this circle. Run up the right side of the arena past the center marker and do a right rollback at least 20 feet (6meters) from the wall or fence-no hesitation.
7. Continue around previous circle but do not close this circle. Run up the left side of the arena past the center marker and do a left rollback at least 20 feet (6 meters) from the wall or fence-no hesitation.
8. Continue back around previous circle but do not close this circle. Run up the right side of the arena past the center marker and do a sliding stop at least 20 feet (6 meters) from the wall or fence. Back up at least 10 feet (3 meters). Hesitate to demonstrate completion of pattern.

PATTERN

14

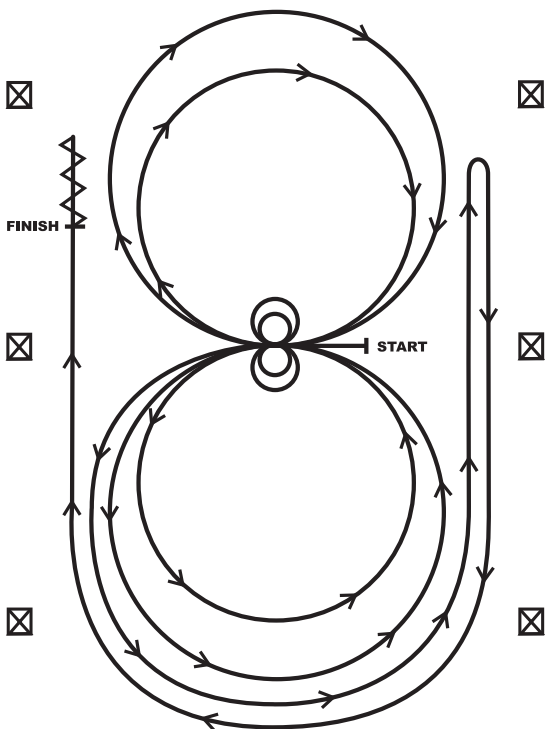

PATTERN

14

To be used for the Youth 10 & Under Short Stirrup class only.

Horses may walk or jog to the center of the arena. Horses must walk or stop prior to starting the pattern. Beginning at the center of the arena facing the left wall or fence.

1. Beginning on the left lead, complete two circles to the left. Stop at the center of the arena. Hesitate.
2. Complete two spins to the left. Hesitate.
3. Beginning on the right lead complete two circles to the right. Stop at the center of the arena. Hesitate.
4. Complete two spins to the right. Hesitate.
5. Beginning on the left lead, go around the end of the arena, run down the right side of the arena past center marker, stop and roll back right.
6. Continue around the end of the arena to run down the left side of the arena past the center marker. Stop. Back up. Hesitate to demonstrate completion of the pattern.

See the Judges' Guide for a summary of other allowances made in the *Handbook*.

PATTERN

15

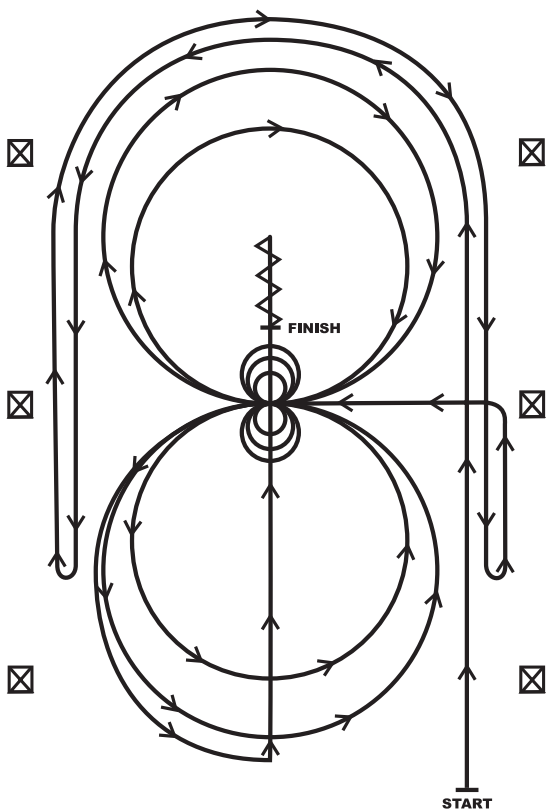

PATTERN

15

To be used for the Youth 10 & Under Short Stirrup class only.

1. Beginning, lope straight up the right side of the arena, circle the top of the arena run straight down the opposite or left side of the arena past the center mark and do a right rollback—no hesitation.
2. Continue straight up the left side of the arena circle back around the top of the arena run straight down the right side of the arena past the center marker and do a left rollback—no hesitation.
3. Continue up the right side of the arena to the center marker, at the center marker the horse should be on the left lead and complete two circles to the left, one large fast and one small slow. Stop at center
4. Complete three spins to the left. Hesitate.
5. Complete two circles to the right, one large fast and one small slow. Stop at center.
6. Complete three spins to the right. Hesitate.
7. Begin a large circle to the left, do not close the circle. Continue up the center of the arena past the center marker and do a sliding stop.
8. Back up at least ten feet. Hesitate to demonstrate completion of the pattern.

See the Judges' Guide for a summary of other allowances made in the *Handbook*.

Join NRHyA

★ *Scholarship Cash*

★ *Endless Fun*

★ *Great Rewards*

Young reiners can enjoy the world of Reining with the National Reining Horse Youth Association. NRHyA members can experience the thrill of youth competition, reap great rewards, advance their leadership qualities outside of the show pen and earn scholarship cash!

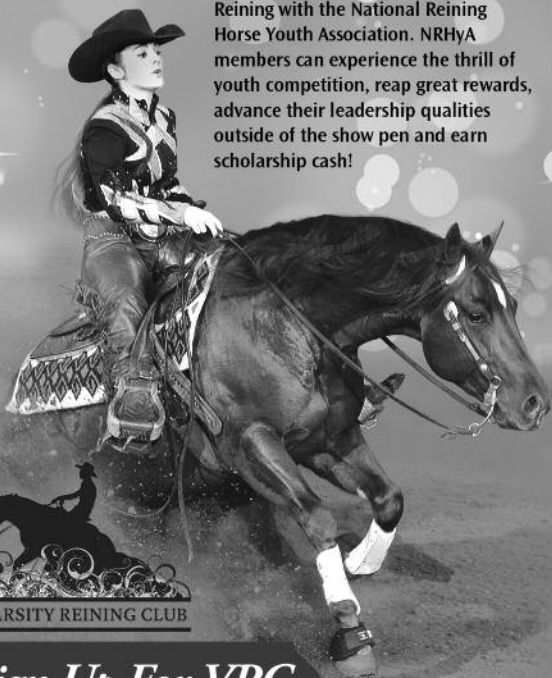

VARSITY REINING CLUB

Sign Up For VRC

Get recognized for your involvement outside of the show arena:

- Open to all NRHyA Members
- Earn Scholarships & Other Great Prizes

Check the website each month for your chance to earn double points!

#SlideOfYourLife

NRHyA

national reining horse
405-946-7400

youth association
nrhya.com



Revised December 2016

REVISED DECEMBER 2016